



## ARTICLE

# This is the way: Network perspective on targets for spatial ability development programmes

Maxim Likhanov<sup>1</sup>  | Ekaterina Maslennikova<sup>2</sup> | Giulio Costantini<sup>3</sup>  |  
Anna Budakova<sup>4</sup> | Elena Esipenko<sup>4</sup> | Victoria Ismatullina<sup>5</sup> |  
Yulia Kovas<sup>6</sup> 

<sup>1</sup>Center for Educational Neuroscience (CEDNe), ITMO University, Saint-Petersburg, Russia

<sup>2</sup>Russian Academy of Education, Moscow, Russia

<sup>3</sup>Department of Psychology, University of Milan-Bicocca, Milan, Italy

<sup>4</sup>Laboratory for Cognitive Investigations and Behavioral Genetics, Tomsk state university, Tomsk, Russia

<sup>5</sup>Behavioural Developmental Genetics Lab, Psychological Institute of Russian Academy of Education, Moscow, Russia

<sup>6</sup>Department of Psychology, Goldsmiths University of London, London, UK

## Correspondence

Yulia Kovas, Department of Psychology, Goldsmiths University of London, New Cross, London SE14 6NW, UK.  
Email: [y.kovas@gold.ac.uk](mailto:y.kovas@gold.ac.uk)

## Funding information

Russian Science Foundation, Grant/Award Number: 20-78-10135; ITMO Fellowship and Professorship Program

## Abstract

**Background:** Spatial ability (SA) was shown to be important for success in different fields, including STEM. Recent research suggested that SA is a unitary construct, rather than a set of related skills. However, it is not clear how individual differences in different facets of SA emerge, and how they relate to variance in general cognitive ability.

**Aims:** The aim of the present study was threefold: 1) to examine the structure of SA testing nine theoretical models; 2) to explore the relation between 16 different facets of SA with general cognitive ability; and 3) to identify central facet(s) within the network of SA – with most links and/or strongest links to other facets.

**Sample:** The study participants were 958 university students from Russia.

**Methods:** The study used a comprehensive battery of 16 SA tests and a verbal ability measure.

**Results:** Results supported previous research, suggesting moderate overlap between all SA facets. Factor analysis suggested several potential structures, with similar fit indices for five different theoretically driven models, including split into small- and large scale; partially independent manipulation, visualization and navigation facets. Confirmatory factor analysis, mediation and network analyses showed spatial

This is an open access article under the terms of the [Creative Commons Attribution-NonCommercial License](https://creativecommons.org/licenses/by-nc/4.0/), which permits use, distribution and reproduction in any medium, provided the original work is properly cited and is not used for commercial purposes.

© 2022 The Authors. *British Journal of Educational Psychology* published by John Wiley & Sons Ltd on behalf of British Psychological Society.

ability being largely independent from verbal ability. In addition, network analysis showed that navigation according to directions is in the centre of the network, potentially linking all SA facets.

**Conclusion:** The results have potential implications for identifying the best targets for SA interventions. The next step in research is conducting experimental studies to evaluate effectiveness of interventions targeting navigation in comparison with other facets of SA.

#### KEYWORDS

centrality measures, educational intervention, factor structure, network centrality, spatial ability

## INTRODUCTION

Spatial ability (SA) is defined as ‘the ability to generate, recall, maintain and manipulate visual-spatial images and solutions’ (Lohman, 1996) and was shown to be a robust predictor of success in Science, Technology, Engineering and Mathematics (STEM) and related fields (Kell et al., 2013). Despite its importance, spatial ability training and diagnostics is somewhat omitted in current educational programmes. For example, one recent study (Lakin & Wai, 2020) has shown that spatially gifted adolescents are usually not identified by commonly used talent identification programmes and thus experience educational disengagement and have more behavioural problems than their identified peers with verbal/maths giftedness. Another study showed that training of visuospatial working memory and spatial reasoning enhanced maths learning in a randomized study of 17 thousand children (Judd & Klingberg, 2021). While there are some attempts to include spatial ability in educational systems (Castro-Alonso & Uttal, 2019; Kell et al., 2013; Likhanov et al., 2021; Stieff et al., 2014; Stieff & Uttal, 2015), it is important to further explore the nature of spatial ability and identify potential aims for interventions.

Many studies to date explored the structure of SA, with several components emerging (see Aristova et al., 2018 for review), such as: spatial visualization (Lohman, 1996), spatial orientation (Hegarty et al., 2006), spatial imagination (Jansen, 2009), mental rotation (Shepard & Metzler, 1971) and spatial relations (Lohman, 1996). Different models of SA structure have been proposed based on opposition of two (e.g. spatial visualization and spatial orientation (Kozhevnikov & Hegarty, 2001); three (navigation, object manipulation and visualization (Malanchini et al., 2020); or more components (see e.g. static/dynamic and intrinsic/extrinsic classification (Uttal et al., 2013). For example, one of the suggested structures is opposition of small- and large-scale spatial abilities (Allen et al., 1996; Cutting & Vishton, 1995; Ittelson, 1973; Silverman & Eals, 1992). The small-scale group includes SA components that are linked with mental operations with objects (Jansen, 2009): visualization (Mix et al., 2017), transformation (Zacks et al., 2000), mental rotation (Blajenkova et al., 2005) and manipulation (Kozhevnikov & Hegarty, 2001). The large-scale SA is connected with changes in the spectator's visual perspective, while other objects' positions remain the same (Hegarty, 2004) and includes spatial orientation, object location from the spectator's point of view and an ability to assess the direction and distance (Jansen, 2009), navigation ability (Kozhevnikov et al., 2006), sense of direction (De Beni et al., 2006), spatial orientation (Kozhevnikov & Hegarty, 2001), and other abilities. However, the discussion regarding SA structure is ongoing as even group membership of some SA components is still under debate. For example, perspective-taking is argued to be small scale by some researchers (Rimfeld et al., 2017) and large scale by other ones (Kozhevnikov & Hegarty, 2001).

Despite some endorsement of researchers on the existence of small- and large-scale SA, what remains unclear is the relationship between them and their relations with other cognitive domains. Several models have been proposed (see (Hegarty et al., 2006) for a review), including: 1) the ‘unitary model’ that assumes that both skills overlap completely; 2) the ‘total dissociation model’ that assumes that the skills are distinct; 3) the ‘partial dissociation model’ that assumes that the abilities have similarities and differences; 4) and the ‘mediation model’ that assumes that small- and large-scale skill are linked, but this link is mediated by a third variable (i.e., intelligence). However, most previous studies used a small number of tests, which precluded thorough investigation of SA factor structure.

One study that used ten SA tests (Rimfeld et al., 2017) found that a general factor of spatial ability captures a substantial proportion of variance in SA in a UK population, and that commonalities across tests are largely explained by shared genetic variance. Another study (Likhanov et al., 2018) further confirmed the unifactorial structure of SA in a Russian student sample but showed a two-factorial structure in a Chinese sample. Such differences in patterns were discussed by the authors in the framework of cross-cultural differences, i.e. specific features of the Chinese language. However, a limitation of these studies is the lack of measures of spatial orientation, e.g. navigation or map reading. One recent study (Malanchini et al., 2020) has addressed this limitation and explored SA factorial structure, using 16 tests, including navigation. The study results showed that SA has hierarchical structure with three factors: ‘Navigation,’ ‘Object Manipulation’ and ‘Visualization’ that load onto a general factor of SA. Moreover, the study showed that SA was somewhat independent from general intelligence.

An important practical implication of determining the structure of SA is identification of most effective measures for diagnostics, talent identification as well as targets for SA development programmes. Absence of the definitive SA structure partly explains the fact that SA tests are not routinely used in educational practice – it is not clear which test with the best validity and predictive power to use for a quick diagnostic in the classroom (see e.g., (Budakova et al., 2021). Moreover, research has shown differential links between different SA facets and academic performance. For example, mental rotation was related to maths performance in kindergarten; whereas in sixth graders visuospatial working memory and form copying were significantly related to the maths performance (Mix et al., 2016). In addition, several studies explored different malleability of different SA facets and transfer of training effect from one facet to another, using different methods, including video games or spatial task training (e.g. (Hawes et al., 2015; Uttal et al., 2013). For example, a series of studies (Jansen, 2009; Jansen et al., 2010) investigated whether large-scale SA would change if participants are provided with small-scale SA training. The study showed that small-scale SA training lead to decreased number of errors in large-scale SA task in adults, but not in adolescents. To summarize, the complex links and interactions across different tests to measure SA are yet to be identified.

Factor and correlational analysis (that are commonly used to investigate SA structure) do not necessarily reveal shared underlying causal structures (e.g., a common general process), but can also reflect specific causal, homeostatic or logical relationships among more specific constructs (Cramer et al., 2012). For example, one might perform better in a 3D task because of their high performance in 2D task (a correlation of .54 was found between the two in a recent study (Budakova et al., 2021). Their correlation might be driven by the need of one SA process for performing in another one, as even the task for e.g. 3D drawing is formulated as follows: ‘Sketching a 3D drawing from a 2D diagram.’ Similarly, the relationship between mental rotation and navigation could be explained by the fact that mental rotation is a cognitive process involved in navigation (Clint et al., 2012), without assuming that rotation and navigation stem from some ‘master’ SA. Rather an individual needs to constantly compare the object they walking by and seeing from different angles with a mental image of this object, and thus these abilities are linked.

Network analysis allows to gain a deeper understanding of the nature of relationships among a set of variables, without necessarily postulating the existence of common underlying factors (see a recent review by (Borsboom et al., 2021). This analysis has been applied in different domains,

including personality (Costantini et al., 2015; Cramer et al., 2012), psychopathology (Borsboom & Cramer, 2013; Cramer & Borsboom, 2015; Fried et al., 2016; McNally et al., 2015; Robinaugh et al., 2014) and cognitive ability, specifically intelligence (Conte et al., 2020; Van Der Maas et al., 2006). For example, network perspective has brought insights into potential candidates for interventions, with high centrality nodes being considered as more promising candidates for manipulation/intervention than others in treatment of mental disorders (Cramer & Borsboom, 2015). In other words, because highly central nodes have more and stronger connections to other nodes than do low-centrality nodes (by definition), they may have greater influence on overall network, be more influenced by overall network, or both.

By identifying the most central nodes in SA network, we can provide information for future interventions aimed at enhancing spatial ability. For example, one recent study that used Network Intervention Analysis (Blanken et al., 2019) demonstrated sequential and symptom-specific effects of a treatment aimed to relief symptoms of insomnia and depression. The study showed that cognitive-behavioural therapy affected different facets of insomnia across 10 weeks. For example, treatment was directly related to ‘early morning awakenings’ in weeks 2, 4, 7 and 9, and ‘difficulty maintaining sleep’ in weeks 3, 4, 6, 7, 8 and 9.

In addition, a recent study that used network analysis (Neubeck et al., 2022) to investigate complex relationships across eight cognitive measures has provided novel insights into cognitive ageing by: 1) identifying differences in the cognitive performance network of younger vs. older adults; 2) finding stronger connection between working memory and intelligence in older adults; and 3) identifying Speeded attention as a key variable in younger adults' cognitive performance network. Moreover, network analysis allows to identify complex interactions between SA facets in the network that eventually can be used to build a dynamic model of reciprocal causal links within SA network (see e.g. mutualism model of intelligence; (Van Der Maas et al., 2006).

Thus, the current study aims to:

- Explore the SA structure, using a comprehensive battery of 16 measures of SA, previously used in Malanchini and colleagues (Malanchini et al., 2020; English version) and Likhanov and colleagues (Likhanov et al., 2018; Russian version), as well as a measure of verbal ability – testing several theoretical models in a sample of Russian students;
- To identify central facet(s) within the network of SA – with most links and/or strongest links to other facets.

## MATERIALS AND METHODS

### Sample

The data were collected from 958 participants (35.01% males; age ranged from 16.03 to 41.70;  $M_{age} = 19.91$ ;  $SD = 4.12$ ) attending five leading universities in different cities in Russia (Moscow, Chelyabinsk and Tomsk). Three universities are included in the top ten and two in the top 100 Russian universities.

### Procedure

Participants filled in a demographic questionnaire, completed two online batteries: ‘King's Challenge’ (Rimfeld et al., 2017) and ‘Spatial Spy’ (Malanchini et al., 2020) and verbal ability test. Participants for the study were recruited via social networks and adverts. The data were collected at the universities in one 1.5-hour session in similar conditions across all data collection sites, using laboratory laptops.

The study was approved by the Ethical Committee for Interdisciplinary Investigations, Tomsk State University. Participants (the students) received information regarding the goals of the study, the voluntary basis of their participation and provided written informed consent. Additional consents were not obtained from parents of participants from 16 to 18 years old as they are formally recognized as students and are allowed to make decisions themselves.

## Measures

Participants provided information on their age, sex and level of education, using an online questionnaire.

### King's challenge battery

This object-based battery includes ten spatial tests capturing the major dimensions of spatial ability, described in [Table 1](#). Participants engage in building and protecting the King's Castle, with all tests linked by the same storyline. Each test was presented as a 2D or 3D pictures together with answer options. For additional information on creation of the battery, see supplementary online information in Rimfeld and collaborators (Rimfeld et al., 2017). We scored each test as the number of correct items. The battery showed moderate-to-high reliability in previous research using the same student sample, with split-half reliability ranging from .56 to .88 (Likhanov et al., 2018).

### 'Spatial spy' battery

The 'Spatial Spy' battery (Malanchini et al., 2020), adapted to Russian, was used to measure orientation and navigation abilities. Participants were invited on a quest, collecting clues while orienting and navigating around the streets of a virtual environment (similar to action video games). All tests were administered in a time-limited format. The battery started with a training session that helped participants to become acquainted with using a mouse for navigating around the virtual

TABLE 1 Description of the ten tests from the King's challenge battery

Test name (abbreviation)	N of items	Time limit per item (sec)	Measured construct/task description
Cross-sections (objCS)	15	20	Visualizing cross-sections of objects
2D drawing (obj2d)	5	45	Sketching a 2D layout of a 3D object from a specified viewpoint
Pattern assembly (objpa)	15	20	Visually combining pieces of objects together to make a whole
Elithorn mazes (objem)	10	7	Joining together as many dots as possible from an array
Mechanical reasoning (objMecR)	16	25	Multiple-choice naïve physics questions
Paper folding (objPF)	15	20	Visualizing the placement of holes, made by punching through a folded piece of paper
3D drawing (obj3d)	7	70	Sketching a 3D drawing from a 2D diagram
Shape rotation (objRot)	15	20	Mentally rotating objects
Perspective-taking (objPT)	15	20	Visualizing objects from a different perspective
Mazes (objMaz)	10	25	Searching for a way through a 2D maze in a time-limited task

TABLE 2 Description of the six tests from the spatial spy battery

Test	N of missions <sup>a</sup>	Time limit per mission (sec)	Description	Split-half reliability
Map Reading (MR)	5	60	Ability to read a map when travelling from one location to another. Participants were instructed to get from A to B by finding the fastest route on a map.	.63
Memorizing a Route (RM)	5	120	Ability to travel from one location to another by remembering the content of a map. Participants were given 20 seconds to memorize the map and plan the route before travelling from A to B.	.65
Navigation according to directions (ND)	5	180	Ability to navigate around a virtual environment, following instructions based on directions. Participants were instructed to navigate around the virtual city in terms of compass points (north, south, east and west).	.80
Navigating based on reference landmarks (NL)	5	60	Ability to navigate around a virtual environment following instructions based on the descriptive features of the destination or other nearby landmarks.	.63
Large-scale scanning ability (SC)	5	60	Ability to quickly process visual information and identify a target object, a black briefcase, located somewhere nearby within the virtual city.	.59
Large-scale perspective-taking (PT)	5	60	Ability to identify objects from a different perspective in large-scale 'naturalistic' settings.	.54

<sup>a</sup>The gamified approach required a complex scoring procedure. For each tests participants engaged in a number of missions – 4–6 items to be completed in order to achieve the goal of the mission. Each item was scored separately, but the failure to complete the mission within the allocated time led to overall score of zero for the mission. The final score for each test was calculated by combining the accuracy and reaction time (equally weighted) for all missions.

environment. Description of each test presented in Table 2. Scoring procedure was different for each tests (see details on scoring and other detailed information in Malanchini and collaborators (Malanchini et al., 2020). Only standardized scores are reported in the current paper. The battery showed excellent test–retest reliability in previous research (Malanchini et al., 2020) and moderate-to-high reliability in the current sample, with split-half reliability ranging from .54 to .80, and is reported in Table 2.

## Verbal ability test

Passive vocabulary volume was assessed with the short version of 'My Vocab' test and was used in a current study as a proxy to verbal ability (correlations between it and other measures of verbal ability were shown to range from 0.39 to 0.55; (Maslennikova et al., 2017). The 'My Vocab' (Golovin, 2015) is similar in design to the Mill Hill Vocabulary Scale (Raven, 1958). The test consists of 99 test words: 95 real words and 4 fake words. Participants are instructed to select only the words for which they know a meaning. Fake words are used to assess whether participants complete the task honestly, in other words do not pick the words that do not exist. As fake words explained less than 1% of variance in overall accuracy for the test they were excluded from the analysis. The sum of all correct words was used as a measure of verbal ability (VOCfin).

## Statistical analysis

### Data preparation

Before any analysis, we excluded 130 participants, who were below the consent age for this study (16 years old), or above a 100 – both likely to be an entry mistake. A preliminary analysis of data has shown that SA scores for all tests vary as a function of sex (See Table S1 in SOM). This is consistent with previous research (see, for example, (Likhanov et al., 2018; Toivainen et al., 2018; Tosto et al., 2014) and verbal ability (Freeman & Garces-Basca, 2015; Stoet & Geary, 2013). Therefore, for further analysis sex differences were regressed out (i.e. variability related to sex was partialled out from all SA scores), as per procedure suggested by Kohler and Kreuter (Kohler & Kreuter, 2012, p. 278). Age was also regressed out from SA scores, as there were correlations between age and SA shown in this sample (See Table S2 in SOM) and in previous studies (Berkowitz et al., 2021; Rodic et al., 2015). These standardized residuals were used for all analyses: correlations, factor and network analysis. Outliers were deleted based on the interquartile range (IQR), i.e., [25th percentile] –  $1.5 \times \text{IQR}$  and [75th percentile] +  $1.5 \times \text{IQR}$  (McGill et al., 1978).

### Confirmatory factor analysis

The fit of nine theoretical models was assessed (see Table 3 for the full list). Model fit indices were used to compare models between each other. Several fit indices were used: a) the Chi-square test, which indicates the correspondence between the expected and the observed covariance matrices (a chi-square value close to zero indicates greater correspondence between them); b) the Comparative Fit Index (CFI) is an incremental fit index that is based on the non-centrality measure. The CFI ranges from 0 to 1, with values closer to 1 indicating better fit (acceptable values  $> .90$ ); c) the Root Mean Square Error of Approximation (RMSEA) is related to residuals in the model. RMSEA values range from 0 to 1, with smaller RMSEA values indicating better model fit. Acceptable model fit is indicated by an RMSEA value of 0.08 or less (Hu & Bentler, 1999); d) Akaike Information Criterion (AIC) is a comparative measure of fit and so it is meaningful only when two different models are estimated. Lower values indicate a better fit and so the model with the lowest AIC is the best fitting model (Kenny, 2015).

### Network analysis

Gaussian Graphical Model Networks (GGM; (Epskamp et al., 2018) were used to examine the connections among ten small-scale and six large-scale spatial ability tests and verbal ability. GGMs were estimated using a lasso regularization via the graphical lasso algorithm, which reduces overfitting and increases replicability of the network models (Epskamp & Fried, 2018). GGMs can be seen as parsimonious models that encode predictive relationships among a set of variables, in the form of partial correlations. Unlike Structural Equation Modelling (SEM) and similar techniques, GGM allow for the examination of all possible pairwise relationships among a large number of variables (Costantini et al., 2019). Like SEM, GGMs result in sparse models that include a limited number of parameters. In GGM networks, if two nodes (variables) are not connected, in other words, are not linked by an edge (connection), this means that they are linearly independent controlling for the other variables (i.e. not correlated when controlled for other variables in the network; (Lauritzen, 1996). This makes GGM more informative than a simple correlational model (Costantini et al., 2015). GGM can potentially highlight causal pathways (see (Epskamp et al., 2018) for a thorough discussion about causal interpretations of network models).

Once a network is computed, node predictability can be used to quantify the proportion of variance of each node that is explained within the network model. Nodes with zero predictability value cannot

TABLE 3 Theoretical models tested with confirmatory factor analysis

Model name	Measures included
Model 1 “Single Navigation factor”:	This model included six tasks from ‘Spatial Spy’ battery (navigation according to directions, navigation according to landmarks, map reading, route memory, large-scale perspective-taking, scanning), loading on a single factor
Model 2 “Single SA factor”	This model included ten object manipulation tasks (cross-sections, 2D drawing, pattern assembly, elithorn maze, mechanical reasoning, paper folding, 3D drawing, shape rotation, perspective taking, mazes) and six spatial orientation tasks (navigation according to directions, navigation according to landmarks, map reading, route memory, large-scale perspective-taking, scanning), loading onto single factor.
Model 3 ‘Small- vs. large-scale factors’	This model investigated fit for ten object manipulation tasks (cross-sections, 2D drawing, pattern assembly, elithorn maze, mechanical reasoning, paper folding, 3D drawing, shape rotation, perspective taking, mazes) and six spatial orientation tasks (navigation according to directions, navigation according to landmarks, map reading, route memory, large-scale perspective-taking, scanning), loading onto ‘Small-scale SA’ and ‘Large-scale SA’ factors, respectively. Division to small- and large-scale SA repeats the division of all tests into two batteries: King's Challenge and Spatial Spy; that were used in the current study.
Model 4 ‘Spatial orientation vs. Object manipulation’	This model included two factors, that were based on theoretically-driven differences between the constructs. The first factor of ‘Spatial Orientation’ included navigation according to directions, navigation according to landmarks, map reading, route memory and two tests from the object-based battery, elithorn maze and mazes. The second factor of ‘Object Manipulation’ included the eight remaining tests from the object-based battery along with the scanning and perspective-taking measures that were included into the spatial orientation battery.
Model 5 ‘Manipulation, Visualization and Navigation’	This model assessed a three factorial structure: 1) ‘Manipulation’ that included cross-sections, 2D drawing, pattern assembly, mechanical reasoning, paper folding, 3D drawing, perspective taking; 2) ‘Visualization’ – shape rotation, elithorn maze, mazes, large-scale perspective-taking, scanning; and 3) ‘Navigation’ that included navigation according to directions, navigation according to landmarks, map reading, route memory (Malanchini et al., 2020).
Model 6 ‘General SA factor’	This model repeated the Model 5, but these three factors now loaded onto a superordinate ‘General spatial ability’ factor (Malanchini et al., 2020).
Model 7 ‘General SA factor + verbal ability’	This model repeated the Model 6, but also included verbal ability factor, which consisted of only VOCfin test. Verbal ability was added to investigate the links between verbal ability and general SA factor.
Model 8 ‘Small- vs. large-scale SA + verbal ability’	This model repeated Model 3, but also included verbal ability factor, which consisted of only VOCfin test. Verbal ability was added to investigate the links between it and two factors of SA.
Model 9 ‘Mediation model’	This model tested whether the link between small- and large-scale SA is mediated by verbal ability (Hegarty et al., 2006).

be predicted by the model, whereas nodes with a predictability value of 1 can be perfectly predicted (Haslbeck & Waldorp, 2018).

Centrality of nodes was assessed with three metrics: (1) Strength quantifies how well a node is directly connected to other nodes and it is calculated as the sum of the weights of the connections involving a node, in absolute values. (2) Closeness quantifies how well a node is directly or indirectly connected to other nodes, and is calculated as the inverse of the sum of the distances of the focal node from all the other nodes in the network. (3) Betweenness quantifies how important a node is in the connecting other



nodes and is calculated as the number of the shortest paths (geodesics) between any two nodes that pass through the focal one (Costantini et al., 2015).

We estimated whether network estimates were sufficiently stable using *bootstrap* (Epskamp et al., 2018). In particular, we used the *correlation stability coefficient* (*CS*-coefficient), which allows assessing the stability of node-level indices such as predictability and centrality. Cutoff values of 0.25 and 0.50 respectively indicate sufficient and good stability (Epskamp et al., 2018).

All analysis was performed in the R statistical software package (R Core Team, 2017). Descriptive statistics, reliabilities and correlations were computed using *psych* (Revelle, 2013) and *PerformanceAnalytics* (Peterson, 2020) packages. Principal component analysis was performed using *nFactors*, *stats* and *psych* packages. Confirmatory factor analysis and mediation analysis were performed using *lavaan* package (Rosseel, 2012). Networks were estimated using the packages *bootnet* (Epskamp et al., 2018) and *qgraph* (Epskamp et al., 2012; Epskamp et al., 2018). To relax the normality assumption for network analysis, the nonparanormal transformation was applied with the R package *hug* (Liu et al., 2009; Zhao et al., 2012). The code for this analysis is available together with data at <https://osf.io/d57uw/>.

## RESULTS

### Descriptive statistics

Descriptive statistics for the raw data are presented in Table 4. Given that there were some missing data for age ( $N = 19$ ), gender ( $N = 113$ ) and spatial ability tests ( $N = 0-169$ ), initial sample size reduced after standardize residuals were computed (sex and age were regressed out from all variables). Following this, outliers were deleted from the data (<5% for each individual variable). Means were equal to  $\sim 0$  and SDs were equal to  $\sim 1$  for all variables in the resulted sample ( $N = 775$ ). The descriptive statistics for this sample are presented in Table S3. Further analysis was performed on standardized residuals.

Figure 1 presents the heatmap of the correlations among all variables ( $N = 775$ ). Scatterplots and *p*-values for correlations are presented in SOM (Figure S1).

### Factor analysis

Our first aim was to investigate the factor structure of SA. Given that *N*s were different for different SA measures and that factor analysis requires list-wise deletion of missing values, the factors were estimated on 537 individuals. No imputation methods were used to treat the missing data.

The eigenvalues suggested a two-factor structure (eigenvalues were equal to 5.13 and 1.52; scree-plot is visualized in Figure S2). Factor analysis (principal axis) with two factors and promax rotation was applied to the data (Chi square = 122.13 [89],  $p < .01$ ). Factor analysis showed a clear division to small- and large-scale SA factors, with only two tests loaded onto an unexpected factor – Elithorn mazes and Mazes loaded onto large-scale SA factor. Navigation according to directions showed almost equal loadings to both factors. Factor loadings are shown in Table 5.

### Confirmatory factor analysis for different SA models

Confirmatory factor analysis for different theoretical SA models is presented in Table 6. All models were estimated on a sample of 537 participants and showed good fit as per MacCallum, Browne and Sugawara (MacCallum et al., 1996). Neither of tested models showed a clear advantage in explaining SA structure as per fit metrics.

TABLE 4 Descriptive statistics for study variables (raw data)

	VOCfin	objCS	obj2d	Objpa	Objem	objMecR	objPF	obj3d	objRot	objPT	objMaz	ND	NL	MR	RM	PT	SC
N*	808	958	928	958	848	958	958	958	958	958	958	928	886	880	789	900	795
Mean	61.72	6.63	3.70	6.39	8.42	9.74	8.25	2.55	7.81	4.49	5.34	0.59	0.77	0.80	0.84	0.71	0.91
Std. Deviation	16.21	3.71	1.04	3.08	1.07	2.66	4.29	1.80	4.07	4.12	2.04	0.17	0.07	0.16	0.08	0.19	0.04
Skewness	-0.46	-0.22	-0.79	-0.31	-0.48	-0.07	-0.32	0.31	-0.29	0.74	-0.43	-0.03	-0.44	-0.84	-0.87	-0.62	-0.62
Kurtosis	-0.48	-0.93	-0.15	-0.73	-0.33	-0.38	-1.11	-1.02	-0.99	-0.55	-0.03	-0.55	-0.29	-0.15	-0.10	-0.20	-0.35
Minimum	19.00	0.00	0.73	0.00	5.53	2.00	0.00	0.00	0.00	0.00	0.00	0.08	0.57	0.33	0.61	0.15	0.80
Maximum	95.00	15.00	5.00	13.00	10.00	16.00	15.00	6.79	15.00	15.00	10.00	0.96	0.94	0.99	0.96	1.00	0.99
Range	0-95	0-15	0-5	0-15	0-10	0-16	0-15	0-7	0-15	0-15	0-10	0-1	0-1	0-1	0-1	0-1	0-1

Note: N = [795-958]; \*As the tests were presented as a part of a larger battery and not all participants managed to do all tests, Ns for different tests differed. Different tests included different number of items, thus the means are not directly comparable. VOCfin - verbal ability test; objCS - Cross-sections; obj2d - 2D drawing; objpa - Pattern assembly; objem - Elithorn mazes; objMecR - Mechanical reasoning; objPF - Paper folding; obj3d - 3D drawing; objRot - Shape rotation; objPT - Perspective-taking; objMaz - Mazes; MR - Map Reading; RM - Memorizing a Route; ND - Navigation according to directions; NL - Navigating based on reference landmarks; SC - Large-scale scanning ability; PT - Large-scale perspective-taking.

### Small- and large-scale spatial ability links to verbal ability

Given that model 3 ‘Small- vs. large-scale factors’ showed somewhat higher CFI and TLI indices, we additionally fitted a model that included a division to small- and large-scale SA factors and verbal ability. This model also showed a good fit and moderate correlations between verbal ability and small-scale

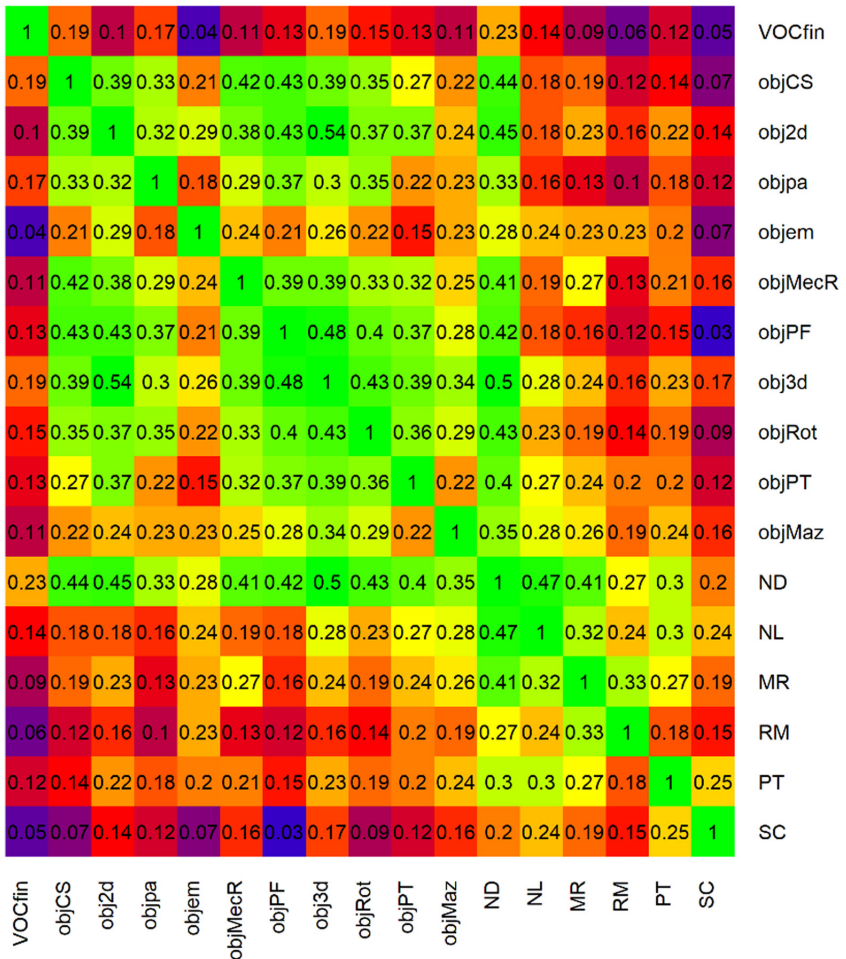
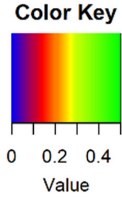

**FIGURE 1** Correlations for 16 spatial ability tests. *Note:* N = [673–775], sex and age was regressed out from all variables for that analysis; VOCfin – verbal ability test; objCS – Cross-sections; obj2d – 2D drawing; objpa – Pattern assembly; objem – Elithorn mazes; objMecR - Mechanical reasoning; objPF – Paper folding; obj3d – 3D drawing; objRot – Shape rotation; objPT - Perspective-taking; objMaz – Mazes; MR - Map Reading; RM – Memorizing a Route; ND – Navigation according to directions; NL – Navigating based on reference landmarks; SC – Large-scale scanning ability; PT – Large-scale perspective-taking; Correlations ranged from weak to moderate and were similar to those reported in Malanchini and colleagues (Malanchini et al., 2020)

TABLE 5 Factor loadings for 16 spatial ability tests

	Factor 1	Factor 2
objCS	0.63	
obj2d	0.65	
objpa	0.50	
objem		0.27
objMecR	0.52	
objPF	0.78	
obj3d	0.65	
objRot	0.57	
objPT	0.42	
objMaz	0.22	0.32
ND	0.40	0.46
NL		0.66
MR		0.62
RM		0.48
PT		0.47
SC		0.41
Variance explained	20%	12%
Cumulative variance explained	32%	

*Note:* objCS – Cross-sections; obj2d – 2D drawing; objpa – Pattern assembly; objem – Elithorn mazes; objMecR – Mechanical reasoning; objPF – Paper folding; obj3d – 3D drawing; objRot – Shape rotation; objPT – Perspective-taking; objMaz – Mazes; MR – Map Reading; RM – Memorizing a Route; ND – Navigation according to directions; NL – Navigating based on reference landmarks; SC – Large-scale scanning ability; PT – Large-scale perspective-taking; Before factor analysis we examined the factorability of the 16 tests in our sample. First, it was observed that 16 out of 16 tests correlated at least .3 with at least one other test, suggesting reasonable factorability (see Figure 1). Secondly, the Kaiser–Meyer–Olkin measure of sampling adequacy turned out to be .91 (above the commonly recommended value of .6; (Cerny & Kaiser, 1997); and Bartlett's test of sphericity was significant ( $\chi^2 [136] = 2191.88, p < .0001$ ), indicating good factorability.

(.23) and large-scale SA factors (.26). Figure 2 presents path diagram for model 8: 16 spatial ability tests and verbal ability.

According to Model 9 ‘Mediation model,’ the link between small- and large-scale SA may be mediated by a third variable (Hegarty et al., 2006). Figure 3 presents results for this model, showing a weak mediation of the link by verbal ability.

## Network analysis of ten small-scale and six large-scale spatial ability tests, and verbal ability

Gaussian Graphical Model was calculated on a sample of 537 participants and is presented in Figure 4, demonstrating different strengths of connections between the nodes of the network. For example, Navigation according to directions test showed a number of the strongest links with other nodes. Specifically, Navigation according to directions showed strong links with Navigation according to landmarks, Map Reading and 3D drawing. Verbal ability test showed a limited number of links with SA tests when controlled for all other variables in the network: weak associations with Navigation according to directions, 3D drawing, Cross-sections and Pattern assembly. Network edges and correlations between the nodes are presented in Table S4.

The predictability of each node (Haslbeck & Waldorp, 2018) is reported in SOM (Table S5). The correlation stability coefficient for predictability was 0.55, indicating good stability (Epskamp et al., 2018). The predictability values had a 95% probability to show a correlation with the original values of at least

TABLE 6 Fit measures for different models

Model	Name	Number of tests	Chi-square (df)	CFI	TLI	RMSEA	SRMR	AIC	BIC
1*	'Single Navigation factor'	six tests from Spatial Spy	23.22 (9)	0.969	0.948	0.054	0.033	6246.2	6297.6
2*	'Single SA factor'	six tests from Spatial Spy + ten King's Challenge tests	324.94 (104)	0.893	0.876	0.063	0.055	18,710	18,847
3	'Small- vs. large-scale factors'	16 SA tests	223.09 (103)	0.942	0.932	0.047	0.051	18,610	18,751
4	'Spatial orientation vs. Object manipulation'	16 SA tests	250.92 (103)	0.928	0.916	0.052	0.047	18,637	18,778
5	'Manipulation, Visualization and Navigation'	16 SA tests	228.79 (101)	0.938	0.926	0.049	0.047	17,398	17,540
6	'General SA factor'	16 SA tests	228.79 (101)	0.938	0.926	0.049	0.047	18,619	18,769
7*	'General SA factor + verbal ability'	16 SA + 1 verbal test	246.06 (116)	0.938	0.927	0.046	0.046	20,064	20,223
8*	'Small- vs. large-scale SA + verbal ability'	16 SA + 1 verbal test	238.12 (117)	0.942	0.933	0.044	0.045	20,054	20,208

Note: Model 3 is treated as a reference model, as it represents clear division between two batteries (small- vs large-scale SA); models that significantly differed from it are marked with \*, models 1, 7 and 8 include different set of variables in comparison with Model 3; models 7 and 8 did not differ significantly from each other in fit indices.

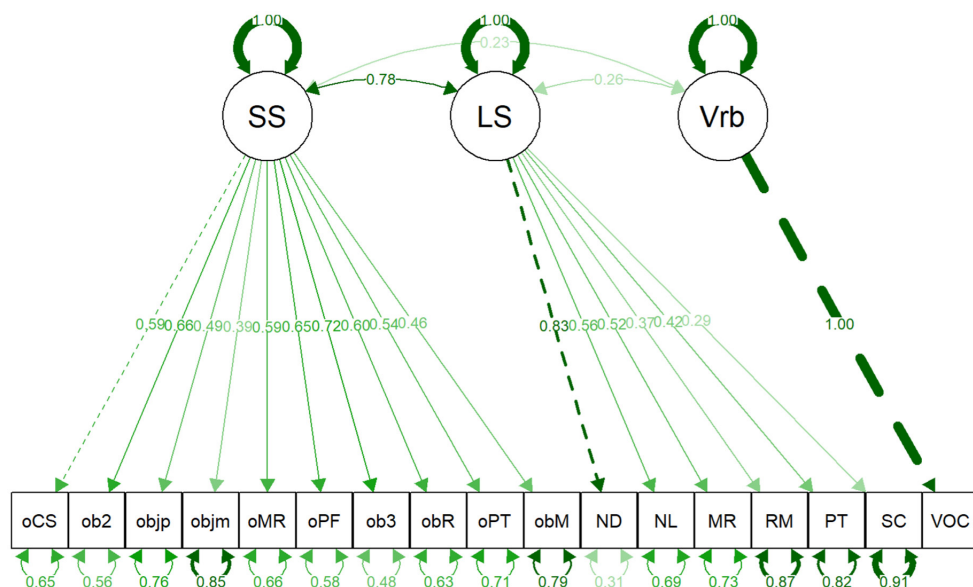

**FIGURE 2** Path diagram for Model 8 includes small- and large-scale SA and verbal ability factors. *Note:* SS – small-scale spatial ability; LS – large-scale spatial ability; Vrb – verbal ability factor; VOC - verbal ability test; objCS – Cross-sections; obj2d – 2D drawing; objpa – Pattern assembly; objem – Elithorn mazes; objMecR – Mechanical reasoning; objPF – Paper folding; obj3d – 3D drawing; objRot – Shape rotation; objPT – Perspective-taking; objMaz – Mazes; MR – Map Reading; RM – Memorizing a Route; ND – Navigation according to directions; NL – Navigating based on reference landmarks; SC – Large-scale scanning ability; PT – Large-scale perspective-taking

0.70, even when 55% of the sample was randomly dropped, thus confirming the accuracy of the predictability index in the overall network.

Centrality measures were also computed (See Figure 5), with the highest Strength, Closeness and Betweenness for Navigation according to directions test (see Table S6 for a full list of centrality indices). The same pattern of indices distribution was shown when verbal ability was deleted from the network. The correlation stability coefficients for Strength, Closeness and Betweenness were in an acceptable range (.55, .35, .54, respectively).

In addition, we performed the same analysis with nonparanormal transformation (Isvoranu et al., 2017) to relax normality assumption, as some variables somewhat deviated from normality as per visual inspection. Recalculated graph showed the same pattern of results (see SOM Figure S3 for the resulting network and Figure S4 for centrality indices). Full list of centrality indices with correction is available in SOM (Table S7).

## DISCUSSION

The current paper aimed to: 1) explore the SA structure, using a comprehensive battery of 16 measures of SA, previously used in Malanchini and colleagues (Malanchini et al., 2020); English version) and Likhanov and colleagues (Likhanov et al., 2018); Russian version), as well as measure of verbal ability – testing several theoretical models in a sample of Russian students; 2) to identify central facet(s) within the network of spatial ability facets – nodes that are linked with most facets and/or more strongly linked to other facets.

Our data showed minimal differences across all study models. Previous research (Malanchini et al., 2020) reported the best fit for hierarchical structure of spatial ability with three factors: object manipulation, visualization and navigation, loading onto general spatial ability factor. Our study replicated

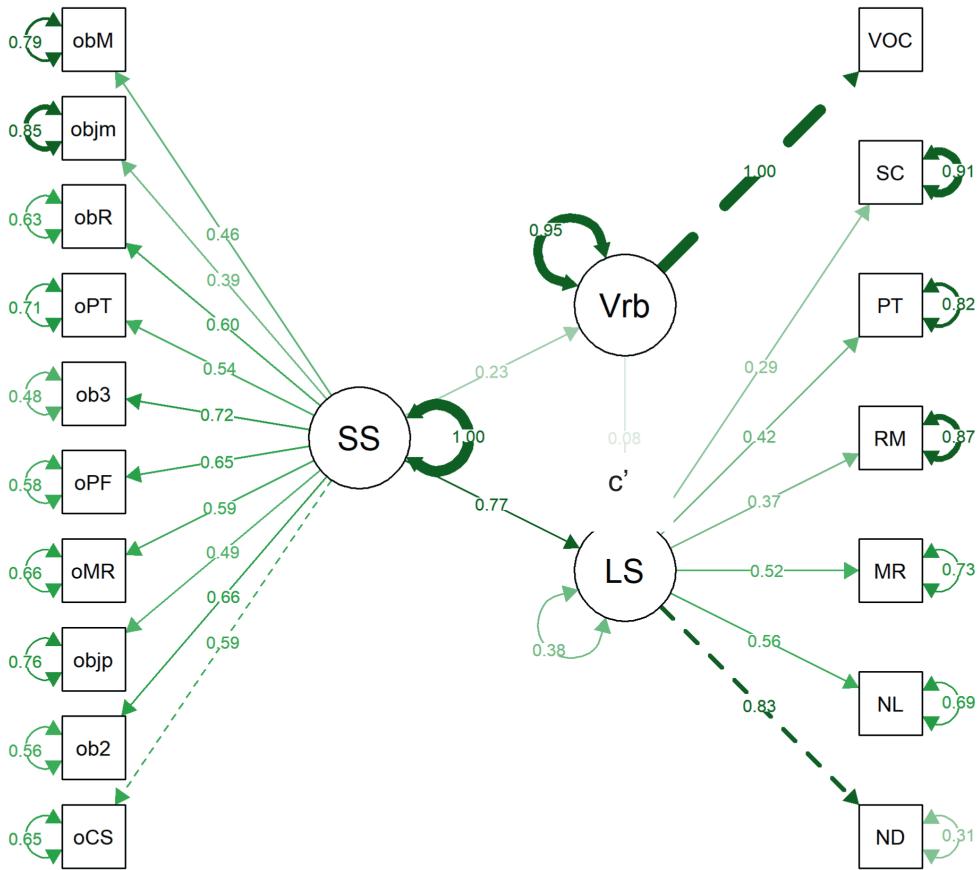

**FIGURE 3** Path model for verbal ability mediating the link between small- and large-scale spatial ability (Model 9). *Note:* standardized regression coefficients for paths a, b and c' are presented, Total effect:  $\beta = 0.78^{***}$ , SE = 0.09, 95% CI [0.89, 1.24], Indirect effect from SS to LS controlling for Vrb:  $\beta = 0.02^*$ , SE = 0.01, 95% CI [0.00, 0.05], SS –small-scale spatial ability; LS – large-scale spatial ability; Vrb – verbal ability factor; VOC – verbal ability test; objCS – Cross-sections; obj2d – 2D drawing; objjpa –Pattern assembly; objem – Elithorn mazes; objMecR – Mechanical reasoning; objPF – Paper folding; obj3d – 3D drawing; objRot – Shape rotation; objPT – Perspective-taking; objMaz – Mazes; MR – Map Reading; RM – Memorizing a Route; ND – Navigation according to directions; NL – Navigating based on reference landmarks; SC – Large-scale scanning ability; PT – Large-scale perspective-taking

the good fit of this model with very similar fit indices. The variance explained by the higher order factor of spatial ability in underlying factors was also very similar ( $R^2 = .75$  for navigation,  $R^2 = .77$  for object manipulation and  $R^2 = 1.00$  for visualization factor). However, our study also showed equally good fit for other theoretical models: ‘Single SA factor,’ ‘Small- vs. large-scale factors,’ ‘Spatial orientation vs. Object manipulation,’ ‘Manipulation, Visualization and Navigation’ and ‘General SA factor’ (Manipulation, Visualization and Navigation + general SA factor).

Our results are consistent with a number of recent research on SA structure: we found that all spatial tasks are correlated (e.g. (Likhonov et al., 2018)); small-scale measures are somewhat distinct from large-scale measures (two factors; e.g. (Hegarty et al., 2006; Jansen, 2009)); SA divides into: manipulation, visualization and navigation (three factors; (Kozhevnikov & Hegarty, 2001; Newcombe & Shipley, 2015)); and load onto general SA factor (e.g. (Malanchini et al., 2020)). Moreover, network analysis suggested some ‘bridge’ facets that potentially link small- and large-scale spatial ability – navigation according to directions and 3D drawing; similarly to fatigue and sleep disturbances, that link major depressive disorder and Generalized anxiety disorder (Cramer et al., 2010). While our data did not provide one definitive

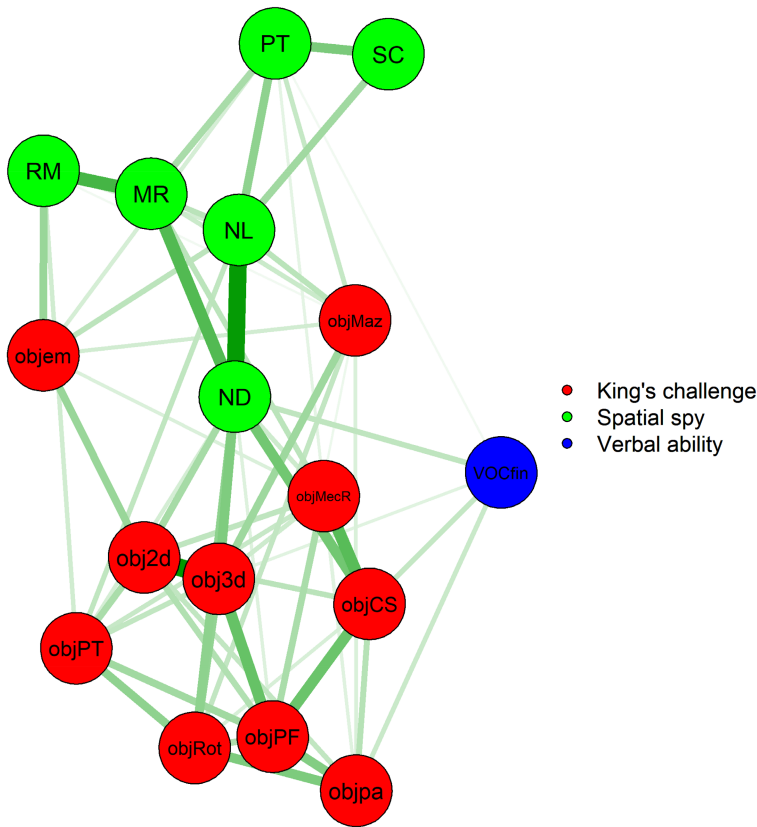
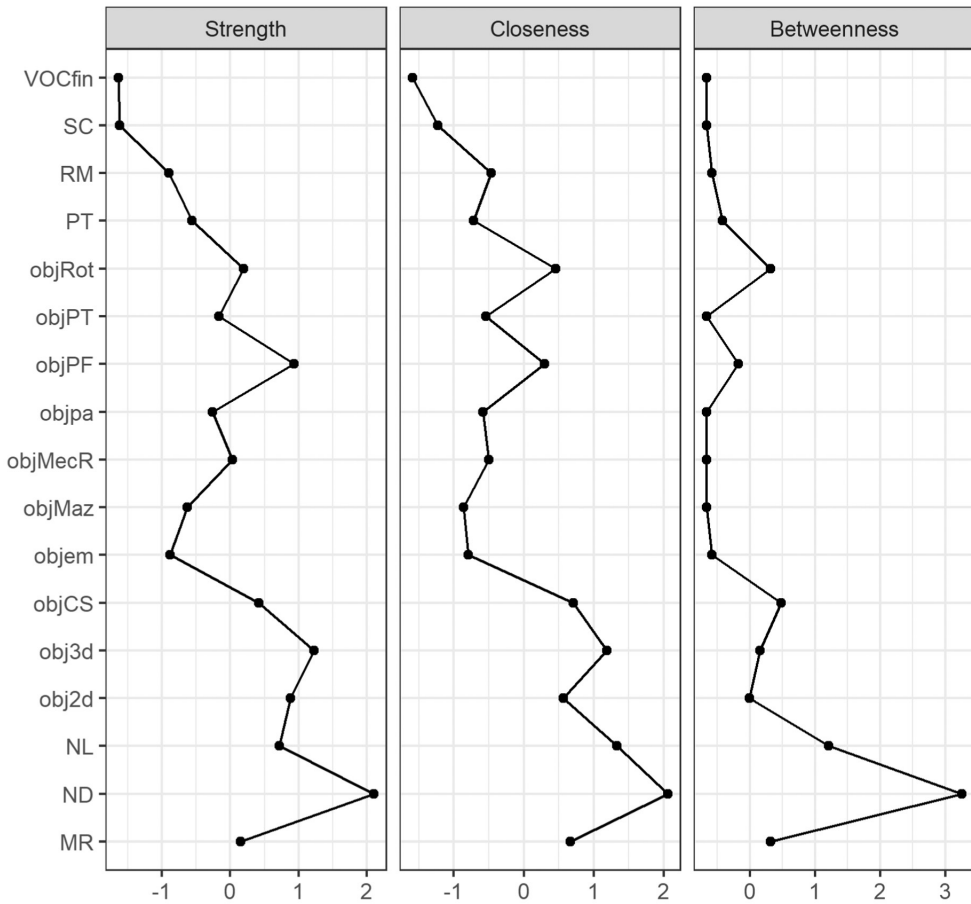

**FIGURE 4** Network of ten small-scale and six large-scale spatial ability tests, and verbal ability. *Note:* Green lines indicate positive connections; red lines indicate negative connections; the thickness of the lines represent the strength of the connection; VOCfin - verbal ability test; objCS - Cross-sections; obj2d - 2D drawing; objpa - Pattern assembly; objem - Elithorn mazes; objMecR - Mechanical reasoning; objPF - Paper folding; obj3d - 3D drawing; objRot - Shape rotation; objPT - Perspective-taking; objMaz - Mazes; MR - Map Reading; RM - Memorizing a Route; ND - Navigation according to directions; NL - Navigating based on reference landmarks; SC - Large-scale scanning ability; PT - Large-scale perspective-taking

answer regarding the spatial ability structure, it provided evidence for rejection of several existing theoretical models. For example, our data showed that small- and large-scale SA overlap substantially, thus rejecting Total Dissociation Model (Hegarty et al., 2006) and showed moderate correlations between spatial and verbal abilities, rejecting models that argue orthogonality for different cognitive abilities (e.g. Multiple intelligences theory; Gardner, 1993).

Furthermore, relatively high correlations between spatial ability tests suggest that general cognitive ability (or general intelligence, 'g'; (Spearman, 1904) might drive individual differences in different spatial ability facets. This (and moderate correlation between spatial and verbal abilities) is in line with prediction from hierarchical model of general intelligence, with communalities of spatial, verbal and quantitative domains distilling the higher-order general intelligence factor (Carroll, 1993). Moreover, correlations among individual measures from King's Challenge and Spatial Spy batteries were weaker (.1-.54) compared with correlations between the small- and large-scale SA factors that emerged from confirmatory factor analysis (.78). This correlation exceeds test-retest correlations shown for the same people measured two times with a 2-week interval (e.g.  $r = .65$  on average for the ten spatial tests (Rimfeld et al., 2017), potentially suggesting existence of general spatial ability factor 's'. Lower correlations between individual tests might be a result of measurement error of each test that was partly





**FIGURE 5** Centrality measures for the network. *Note:* X-axis is in standardized scores to allow for meaningful comparisons across metrics; VOCfin-- verbal ability test; objCS – Cross-sections; obj2d – 2D drawing; objpa -Pattern assembly; objem – Elithorn mazes; objMecR – Mechanical reasoning; objPF – Paper folding; obj3d – 3D drawing; objRot – Shape rotation; objPT – Perspective-taking; objMaz – Mazes; MR – Map Reading; RM – Memorizing a Route; ND – Navigation according to directions; NL – Navigating based on reference landmarks; SC – Large-scale scanning ability; PT – Large-scale perspective-taking

eliminated by factor analysis. In hypothetical situation with zero measurement error in the tests (caused by e.g. different enjoyment of Spatial Spy vs. King's Challenge tests), the correlation between SA factors might be equal to 1 (Spearman, 1987), perfectly reflecting 'g'. The existence of general 's' factor is supported by a study that showed general genetic network that underlies all spatial skills (Malanchini et al., 2020). Research has also shown that individual differences in general spatial ability factor is explained by both genetic (heritability ranged from .52 to .69) and environmental factors (Malanchini et al., 2020; Rimfeld et al., 2017). Further research is needed to investigate the aetiology of spatial ability measured in more ecologically valid environments, for example during everyday activities.

In addition, consistent with previous research, our data showed that SA correlates with other cognitive abilities (Alfred & Kraemer, 2017; Colom et al., 2006; Hegarty et al., 2006; Lee et al., 2006). Specifically, confirmatory factor analysis (Model 8) showed that verbal ability modestly correlated with both small- and large-scale spatial ability factors (.23–.26). One theory of the link between small- and large-scale spatial ability is that they are mediated by general cognitive ability. Mediation analysis indeed showed that there was an indirect path between small- and large-scale SA via verbal ability. However, the effect size for indirect path was negligible ( $\beta = .02$ ), with the direct effect being large and significant

( $\beta = 0.76$ ). Many speculative explanations can be potentially suggested for this indirect effect, such as effect of verbal instructions needed to be read in all SA tests, real contribution of verbal processing when solving spatial problems, etc. However, the small size of this effect, which is probably significant because of a relatively large sample size, advises against proposing substantial interpretations. Indeed, network analysis showed that verbal ability had very weak links with spatial ability tests and was on the periphery of the network (see [Figure 4](#)). Furthermore, network analysis showed that the links were only present for some, mostly small-scale, spatial ability tests, namely cross-sections, pattern assembly, shape rotation and navigation according to directions. A possible explanation might be that these tests rely on verbal instructions more than other tests and are also more complex because of verbal processing. For example, individuals with higher verbal ability might have performed better in navigation according to directions as they needed to process somewhat complex instructions during the task (e.g. 'Go south and take the first road going northeast' and needed to use the compass to find the way at the same time). However, it is unclear why, e.g. mechanical reasoning, did not show this link as it requires a new instruction to be read for each item, while other small-scale tests do not. Perhaps this is due to the fact that this task measures the ability to understand basic mechanical principles and requires not only reasoning (thinking) over the tasks but also remembering these principles and physical laws (fluid vs. crystalized intelligence).

Our results showed slightly lower correlations between spatial and verbal ability in comparison with studies in other languages (.26 in current sample vs. .4–.7 in other studies; see e.g. (Carroll, 1993; Salthouse, 2004). There might be several reasons for correlations of such magnitude in Russian language. Firstly, the current study used scores residualized for age and sex for both spatial and verbal ability tests: subtracting variance related to these two characteristics might have reduced the correlations. Secondly, only one measure of verbal ability (measuring passive vocabulary volume) was used in the current study, whereas for instance, Salthouse (Salthouse, 2004) used a combination of several verbal ability measures. This might have reduced the correlations in the current sample. Thirdly, this study is the first one using SA battery that includes both small- and large-scale SA, and verbal ability test in Russian sample, thus, there might be cross-cultural differences that have driven the lower correlation in Russian sample. For example, correlations of similar magnitude (.12–.30) between several small-scale ability tests and school exam were found in a previous study in Russian language in a sample of gifted adolescents (Budakova et al., 2021). Further research is needed in Russian samples with more comprehensive measures of verbal ability to explore this potential cross-cultural difference.

The second aim of the study was to identify central facet(s) within the network of spatial ability facets – facets that are linked with most facets and/or more strongly linked to other facets. Our data showed that navigation according to directions is central in the network according to all measures of centrality used in the current study: node strength, closeness and betweenness.

Navigation according to directions was shown to be in the centre of SA in-between small-scale SA and other large-scale SA tests. This test taps into the ability to find the way to a particular place according to instructions, an adaptive characteristic likely to be selected for in the course of evolution (Clint et al., 2012). There are several potential explanations for why this ability may be central in the SA network. For example, it may be a more complex trait encompassing other abilities, such as navigation using mental maps of landmarks; cues from the sun and stars; the earth's magnetic field; mental rotation of objects and perspective taking (e.g., imagining landmarks from a different perspective); visuo-spatial working memory; understanding verbal instruction; abstract thought (e.g., compass reading). For example, shape rotation has been found to be an important aspect of navigation (Clint et al., 2012). It is hypothesized that to orient properly, an individual needs to identify environmental features regardless of perspective. In addition, Silverman and colleagues (Silverman et al., 2000) found that performance at mental rotation tests strongly predicted performance at real-world navigation tasks, such as the ability to navigate back to a starting location after moving through the woods. Consistent with this 'complexity' explanation, navigation,

according to directions, was also shown as the most heritable of all spatial orientation tests (.60 as per (Malanchini et al., 2020)). This greater heritability may be a combination of multiple, partially non-overlapping, genetic factors that contribute to the different abilities needed to perform navigation according to directions. Other potential explanations include somewhat higher validity of the test, used to measure navigation according to directions; an instruction for the task that is familiar and easy-to-understand for people who have never played videogames; etc.

Results of network analysis have several theoretical implications for SA research:

1. -It has been recently proposed that network analysis can be a strong tool to generate causal hypotheses (see e.g. (Borsboom et al., 2021; Isvoranu & Epskamp, 2021)). Our results from this analysis indicate that navigation according to directions may be causally linked to some other SA facets (e.g. navigation according to landmarks or 3D drawing ability). Moreover, there might be some chains of prediction inferred from the identified links between SA facets. For example, it can be hypothesized that navigation according to directions ability affects map reading ability, which in turn affect memorizing a route ability (thick lines on Figure 4).
2. -It might be that individual differences in specific aspects of the SA network (i.e. specific patterns of the links between SA facets or centrality indices distributions within networks) are linked to success in STEM beyond links with individual differences in level of SA (e.g. Budakova et al., 2021; Wai et al., 2009).
3. Furthermore, there might be sex differences in SA networks that exist above and beyond reported average sex differences in SA (Tosto et al., 2014), (Toivainen et al., 2018). For example, some links between SA facets might be present in males but absent in females or some SA facets might be linked via different SA facets (i.e. hubs), suggesting sex differences in mechanisms of spatial information processing. These sex differences in networks might be linked to sex differences in engagement in STEM (Makarova et al., 2019). Findings from network analysis might inform which strategies to adopt in SA training (e.g. Stieff et al., 2014).
4. -Moreover, network analysis might provide further insights into the links between different SA facets and achievement in different areas. GGMs – the network analysis used in the present study accounts for all other variables in the network when testing linear dependency between two variables. This approach allows to identify specific SA facets that directly contribute to achievement, which can provide further insights into links between SA and achievement. A similar approach has been used in other recent studies. For example, one study identified that out of eight personality traits only two (Conscientiousness and Neuroticism) contributed to teacher grade in adolescents directly (Papageorgiou et al., 2020).

Hypotheses generated with network analysis need to be further tested using longitudinal and experimental designs (to establish causal links between SA facets), as well as using different measures of achievement (to investigate SA facets linked with academic and occupational performance).

Establishing the central facets in the SA network may have practical implications. Given recent evidence from literature on applications of network analysis (Blanken et al., 2019; Epskamp et al., 2018; Valente, 2012), training of more central abilities may enhance other spatial ability facets. Our results suggest that navigation according to directions could be a possible target for interventions. This conclusion is supported by a meta-analysis that showed extrinsic and static spatial ability being the most malleable (see Table 4; in (Uttal et al., 2013) in comparison with other combinations of internal/external and static/dynamic SA. Extrinsic and static SA is considered to underlie ability to ‘think about the relations among locations in the environment, or on a map’ (Uttal et al., 2013); p. 354), which is supposedly measured by navigation according to directions test. Recent developments in augmented (AR) and virtual reality (VR) allow for easy-to-implement, computerized programmes for spatial abilities development, including spatial orientation (see e.g. (McLaren-Gradinaru et al., 2020)). The next step in this research

programme is to conduct experimental studies assessing whether training of navigation according to directions using AR and VR leads to effect transfers to other spatial ability, and whether this effect is greater compared with interventions targeting other facets of SA.

The study has a number of limitations. Firstly, we are unable to make causal conclusions given that the data are cross-sectional and non-experimental. Secondly, in spite of the large-scale spatial ability tests used showed good reliability in previous research (Malanchini et al., 2020), in our sample these tests showed somewhat lower reliability that could have affected results (e.g. reduced the magnitude of correlations across Large-scale scanning ability and Large-scale perspective-taking, and other SA tests). The lower reliability is likely a product of time limit given for each mission within the task: if participants did not solve the task in time they were assigned with 0 accuracy. Thirdly, due to the requirements for factor and network analysis, we needed to apply list-wise deletion to our data and delete outliers that reduced the initial sample by approximately one third and reduced the power for analysis. However, the results were similar on the full sample (without outliers removal and calculating of residuals). Fourthly, verbal ability in this study was measured by only one test – further research needs to use more comprehensive measures of verbal ability and other cognitive measures to investigate partial independence of spatial ability from ‘g’. Fifthly, some researchers argue that large-scale spatial ability tasks that are implemented in virtual reality are not large-scale per se (see e.g. (Hegarty et al., 2006; Taube et al., 2013)). Further research should employ tasks that involve real-life tasks that include locomotion, along with other laptop-implemented ones.

To sum up, our results suggest navigation according to directions facet of spatial ability as a potential target for interventions. Given the constantly replicating evidence on the importance of spatial ability for achievement in both academic and occupational contexts, we want to again emphasize the need to develop interventions and/or assess effectiveness of the existing ones that aim to develop this particular facet of spatial ability. We hope that our findings on the importance of this facet of spatial ability will inform future work on interventions for spatial ability and, ultimately, lead to development of highly effective ways to improve achievement in STEM and other domains.

## AUTHOR CONTRIBUTIONS

**Maxim Likhhanov:** Conceptualization; formal analysis; investigation; visualization; writing – original draft. **Ekaterina Maslennikova:** Data curation; formal analysis. **Giulio Costantini:** Methodology; validation; writing – review and editing. **Anna Budakova:** Data curation; investigation; writing – review and editing. **Elena Esipenko:** Conceptualization; data curation; writing – review and editing. **Victoria Ismatullina:** Conceptualization; data curation; writing – review and editing. **Yulia Kovas:** Conceptualization; funding acquisition; project administration; supervision; writing – review and editing.

## ACKNOWLEDGEMENTS

This work was supported by the Russian Science Foundation, grant no. 20-78-10135. ITMO Fellowship and Professorship Programme is acknowledged for infrastructural support.

## CONFLICT OF INTEREST

The authors declare that the research was conducted in the absence of any commercial or financial relationships that could be construed as a potential conflict of interest.

## DATA AVAILABILITY STATEMENT

<https://osf.io/d57uw/>

## ORCID

Maxim Likhhanov  <https://orcid.org/0000-0001-6003-741X>

Giulio Costantini  <https://orcid.org/0000-0001-6610-5452>

Yulia Kovas  <https://orcid.org/0000-0001-9633-6374>

## REFERENCES

- Alfred, K. L., & Kraemer, D. J. M. (2017). Verbal and visual cognition: Individual differences in the lab, in the brain, and in the classroom. *Developmental Neuropsychology*, 42(7–8), 507–520. <https://doi.org/10.1080/87565641.2017.1401075>
- Allen, G. L., Kirasic, K. C., Dobson, S. H., Long, R. G., & Beck, S. (1996). Predicting environmental learning from spatial abilities: An indirect route. *Intelligence*, 22(3), 327–355. [https://doi.org/10.1016/S0160-2896\(96\)90026-4](https://doi.org/10.1016/S0160-2896(96)90026-4)
- Aristova, I. L., Esipenko, E. A., Sharafieva, K. R., Maslennikova, E. P., Chlpeeva, N. A., Rklicheva, I. V., Soldatova, E. L., Fenln, A. Yu., Ismatullina, V. I., Matykh, S. B., & Kovas, Yu. V. (2018). Modern approaches in the study of spatial abilities: A structure and etiology of individual differences. *Voprosy Psikhologii*, 2018-January(1), 118–126. Scopus.
- Berkowitz, M., Gerber, A., Thurn, C. M., Emo, B., Hoelscher, C., & Stern, E. (2021). Spatial abilities for architecture: Cross sectional and longitudinal assessment with novel and existing spatial ability tests. *Frontiers in Psychology*, 11, 609363. <https://doi.org/10.3389/fpsyg.2020.609363>
- Blajenkova, O., Motes, M. A., & Kozhevnikov, M. (2005). Individual differences in the representations of novel environments. *Journal of Environmental Psychology*, 25(1), 97–109. <https://doi.org/10.1016/j.jenvp.2004.12.003>
- Blanken, T. F., Van Der Zweerde, T., Van Straten, A., Van Someren, E. J. W., Borsboom, D., & Lancee, J. (2019). Introducing network intervention analysis to investigate sequential, symptom-specific treatment effects: A demonstration in co-occurring insomnia and depression. *Psychotherapy and Psychosomatics*, 88(1), 52–54. <https://doi.org/10.1159/000495045>
- Borsboom, D., & Cramer, A. O. J. (2013). Network analysis: An integrative approach to the structure of psychopathology. *Annual Review of Clinical Psychology*, 9(1), 91–121. <https://doi.org/10.1146/annurev-clinpsy-050212-185608>
- Borsboom, D., Deserno, M. K., Rhemtulla, M., Epskamp, S., Fried, E. I., McNally, R. J., Robinaugh, D. J., Perugini, M., Dalege, J., Costantini, G., Isvoranu, A.-M., Wysocki, A. C., van Borkulo, C. D., van Bork, R., & Waldorp, L. J. (2021). Network analysis of multivariate data in psychological science. *Nature Reviews Methods Primers*, 1(1), 58. <https://doi.org/10.1038/s43586-021-00055-w>
- Budakova, A., Likhonov, M., Toivainen, T., Zhurbitskiy, A., Sitnikova, E., Bezrukova, E., & Kovas, Y. (2021). Measuring spatial ability for talent identification, educational assessment, and support: Evidence from adolescents with high achievement in science, arts, and sports. *Psychology in Russia: State of the Art*, 14(2), 59–85. <https://doi.org/10.11621/pir.2021.0205>
- Carroll, J. B. (1993). *Human cognitive abilities: A survey of factor-analytic studies* (1st ed.). Cambridge University Press. <https://doi.org/10.1017/CBO9780511571312>
- Castro-Alonso, J. C., & Uttal, D. H. (2019). Spatial ability for university biology education. In S. Nazir, A.-M. Teperi, & A. Polak-Sopińska (Eds.), *Advances in human factors in training, education, and learning sciences* (Vol. 785, pp. 283–291). Springer International Publishing. [https://doi.org/10.1007/978-3-319-93882-0\\_28](https://doi.org/10.1007/978-3-319-93882-0_28)
- Cerny, C. A., & Kaiser, H. F. (1977). A study of a measure of sampling adequacy for factor-analytic correlation matrices. *Multivariate Behavioral Research*, 12(1), 43–47. [https://doi.org/10.1207/s15327906mbr1201\\_3](https://doi.org/10.1207/s15327906mbr1201_3)
- Clint, E. K., Sober, E., Garland, T., & Rhodes, J. S. (2012). Male superiority in spatial navigation: Adaptation or side effect? *The Quarterly Review of Biology*, 87(4), 289–313. <https://doi.org/10.1086/668168>
- Colom, R., Jung, R. E., & Haier, R. J. (2006). Distributed brain sites for the g-factor of intelligence. *NeuroImage*, 31(3), 1359–1365. <https://doi.org/10.1016/j.neuroimage.2006.01.006>
- Conte, F., Costantini, G., Rinaldi, L., Gerosa, T., & Girelli, L. (2020). Intellect is not that expensive: Differential association of cultural and socio-economic factors with crystallized intelligence in a sample of Italian adolescents. *Intelligence*, 81, 101466. <https://doi.org/10.1016/j.intell.2020.101466>
- Costantini, G., Epskamp, S., Borsboom, D., Perugini, M., Möttus, R., Waldorp, L. J., & Cramer, A. O. J. (2015). State of the arT personality research: A tutorial on network analysis of personality data in R. *Journal of Research in Personality*, 54, 13–29. <https://doi.org/10.1016/j.jrp.2014.07.003>
- Costantini, G., Richetin, J., Preti, E., Casini, E., Epskamp, S., & Perugini, M. (2019). Stability and variability of personality networks. A tutorial on recent developments in network psychometrics. *Personality and Individual Differences*, 136, 68–78. <https://doi.org/10.1016/j.paid.2017.06.011>
- Cramer, A. O. J., & Borsboom, D. (2015). Problems attract problems: A network perspective on mental disorders. In *Emerging trends in the social and behavioral sciences* (pp. 1–15). American Cancer Society. <https://doi.org/10.1002/9781118900772.etrds0264>
- Cramer, A. O. J., Van Der Sluis, S., Noordhof, A., Wichers, M., Geschwind, N., Aggen, S. H., Kendler, K. S., & Borsboom, D. (2012). Dimensions of normal personality as networks in search of equilibrium: You can't like parties if you don't like people. *European Journal of Personality*, 26(4), 414–431. <https://doi.org/10.1002/per.1866>
- Cramer, A. O. J., Waldorp, L. J., van der Maas, H. L. J., & Borsboom, D. (2010). Comorbidity: A network perspective. *Behavioral and Brain Sciences*, 33(2–3), 137–150. <https://doi.org/10.1017/S0140525X09991567>
- Cutting, J. E., & Vishton, P. M. (1995). Perceiving layout and knowing distances: The integration, relative potency, and contextual use of different information about depth. In *Perception of space and motion* (pp. 69–117). Academic Press. <https://doi.org/10.1016/B978-012240530-3/50005-5>
- De Beni, R., Pazzaglia, F., & Gardini, S. (2006). The role of mental rotation and age in spatial perspective-taking tasks: When age does not impair perspective-taking performance. *Applied Cognitive Psychology*, 20(6), 807–821. <https://doi.org/10.1002/acp.1229>
- Epskamp, S., Borsboom, D., & Fried, E. I. (2018). Estimating psychological networks and their accuracy: A tutorial paper. *Behavior Research Methods*, 50(1), 195–212. <https://doi.org/10.3758/s13428-017-0862-1>

- Epskamp, S., Cramer, A. O. J., Waldorp, L. J., Schmittmann, V. D., & Borsboom, D. (2012). Qgraph: Network visualizations of relationships in psychometric data. *Journal of Statistical Software*, 48(4), 1–18. <https://doi.org/10.18637/jss.v048.i04>
- Epskamp, S., & Fried, E. I. (2018). A tutorial on regularized partial correlation networks. *Psychological Methods*, 23(4), 617–634. <https://doi.org/10.1037/met0000167>
- Freeman, J., & Garcés-Basca, R. M. (2015). Gender differences in gifted children. In M. Neihart, S. I. Pfeiffer, & T. L. Cross (Eds.), *The social and emotional development of gifted children: What do we know?* Prufrock Press Inc.
- Fried, E. I., Epskamp, S., Nesse, R. M., Tuerlinckx, F., & Borsboom, D. (2016). What are “good” depression symptoms? Comparing the centrality of DSM and non-DSM symptoms of depression in a network analysis. *Journal of Affective Disorders*, 189, 314–320. <https://doi.org/10.1016/j.jad.2015.09.005>
- Gardner, H. (1993). *Frames of mind: The theory of multiple intelligences* (10th anniversary ed.). BasicBooks.
- Golovin, G. (2015). Receptive vocabulary size measurement for Russian language. *Social and Psycholinguistic Studies*, 3, 148–159.
- Haslbeck, J. M. B., & Waldorp, L. J. (2018). How well do network models predict observations? On the importance of predictability in network models. *Behavior Research Methods*, 50(2), 853–861. <https://doi.org/10.3758/s13428-017-0910-x>
- Hawes, Z., Moss, J., Caswell, B., & Poliszczuk, D. (2015). Effects of mental rotation training on children's spatial and mathematics performance: A randomized controlled study. *Trends in Neuroscience and Education*, 4(3), 60–68. <https://doi.org/10.1016/j.tine.2015.05.001>
- Hegarty, M. (2004). A dissociation between mental rotation and perspective-taking spatial abilities. *Intelligence*, 32(2), 175–191. <https://doi.org/10.1016/j.intell.2003.12.001>
- Hegarty, M., Montello, D. R., Richardson, A. E., Ishikawa, T., & Lovelace, K. (2006). Spatial abilities at different scales: Individual differences in aptitude-test performance and spatial-layout learning. *Intelligence*, 34(2), 151–176. <https://doi.org/10.1016/j.intell.2005.09.005>
- Hu, L., & Bentler, P. M. (1999). Cutoff criteria for fit indexes in covariance structure analysis: Conventional criteria versus new alternatives. *Structural Equation Modeling: A Multidisciplinary Journal*, 6(1), 1–55. <https://doi.org/10.1080/10705519909540118>
- Isvoranu, A.-M., & Epskamp, S. (2021). Which estimation method to choose in network psychometrics? Deriving guidelines for applied researchers. *Psychological Methods*. <https://doi.org/10.1037/met0000439>. Online ahead of print.
- Isvoranu, A.-M., van Borkulo, C. D., Boyette, L.-L., Wigman, J. T. W., Vinkers, C. H., Borsboom, D., & Group Investigators. (2017). A network approach to psychosis: Pathways between childhood trauma and psychotic symptoms. *Schizophrenia Bulletin*, 43(1), 187–196. <https://doi.org/10.1093/schbul/sbw055>
- Ittelson, W. H. (1973). *Environment and cognition*. (pp. xii, 187). Seminar Press.
- Jansen, P. (2009). The dissociation of small- and large-scale spatial abilities in school-age children. *Perceptual and Motor Skills*, 109(2), 357–361. <https://doi.org/10.2466/pms.109.2.357-361>
- Jansen, P., Wiedenbauer, G., & Hahn, N. (2010). Manual rotation training improves direction-estimations in a virtual environmental space. *European Journal of Cognitive Psychology*, 22(1), 6–17. <https://doi.org/10.1080/09541440802678487>
- Judd, N., & Klingberg, T. (2021). Training spatial cognition enhances mathematical learning in a randomized study of 17,000 children. *Nature Human Behaviour*, 5, 1548–1554. <https://doi.org/10.1038/s41562-021-01118-4>
- Kell, H. J., Lubinski, D., Benbow, C. P., & Steiger, J. H. (2013). Creativity and technical innovation: Spatial Ability's unique role. *Psychological Science*, 24(9), 1831–1836. <https://doi.org/10.1177/0956797613478615>
- Kenny, D. (2015). *Measuring model fit*. Retrieved from: <http://davidakenny.net/cm/fit.htm>
- Kohler, U., & Kreuter, F. (2012). *Data analysis using stata* (3rd ed.). Stata Press.
- Kozhevnikov, M., & Hegarty, M. (2001). A dissociation between object manipulation spatial ability and spatial orientation ability. *Memory & Cognition*, 29(5), 745–756. <https://doi.org/10.3758/BF03200477>
- Kozhevnikov, M., Motes, M. A., Rasch, B., & Blajenkova, O. (2006). Perspective-taking vs. mental rotation transformations and how they predict spatial navigation performance. *Applied Cognitive Psychology*, 20(3), 397–417. <https://doi.org/10.1002/acp.1192>
- Lakin, J. M., & Wai, J. (2020). Spatially gifted, academically inconvenienced: Spatially talented students experience less academic engagement and more behavioural issues than other talented students. *British Journal of Educational Psychology*, 90(4), 1015–1038. <https://doi.org/10.1111/bjep.12343>
- Lauritzen, S. L. (1996). *Graphical models*. Clarendon Press; Oxford University Press.
- Lee, K. H., Choi, Y. Y., Gray, J. R., Cho, S. H., Chae, J.-H., Lee, S., & Kim, K. (2006). Neural correlates of superior intelligence: Stronger recruitment of posterior parietal cortex. *NeuroImage*, 29(2), 578–586. <https://doi.org/10.1016/j.neuroimage.2005.07.036>
- Likhanov, M. V., Ismatullina, V. I., Fenin, A. Y., Wei, W., Rimplfeld, K., Maslennikova, E. P., Esipenko, E. A., Sharafeva, K. R., Feklicheva, I. V., Chipeeva, N. A., Budakova, A. V., Soldatova, E. L., Zhou, X., & Kovas, Y. V. (2018). The factorial structure of spatial abilities in Russian and Chinese students. *Psychology in Russia: State of the Art*, 11(4), 96–114. <https://doi.org/10.11621/pir.2018.0407>
- Likhanov, M. V., Tsigeman, E. S., & Kovas, Y. (2021). Online short spatial ability battery (OSSAB): Psychometric norms for older students. *Sibirskiy Psikhologicheskii Zhurnal*, 78, 117–129. <https://doi.org/10.17223/17267080/78/7>
- Liu, H., Lafferty, J., & Wasserman, L. (2009). *The nonparanormal: Semiparametric estimation of high dimensional undirected graphs*. *ArXiv:0903.0649 [stat]*. <http://arxiv.org/abs/0903.0649>
- Lohman, D. F. (1996). Spatial ability and g. In *Human abilities: Their nature and measurement* (pp. 97–116). Lawrence Erlbaum Associates, Inc.
- MacCallum, R. C., Browne, M. W., & Sugawara, H. M. (1996). Power analysis and determination of sample size for covariance structure modeling. *Psychological Methods*, 1(2), 130–149. <https://doi.org/10.1037/1082-989X.1.2.130>

- Makarova, E., Aeschlimann, B., & Herzog, W. (2019). The gender gap in STEM fields: The impact of the gender stereotype of math and science on secondary students' career aspirations. *Frontiers in Education, 4*, 60. <https://doi.org/10.3389/educ.2019.00060>
- Malanchini, M., Rimfeld, K., Shakeshaft, N. G., McMillan, A., Schofield, K. L., Rodic, M., Rossi, V., Kovas, Y., Dale, P. S., Tucker-Drob, E. M., & Plomin, R. (2020). Evidence for a unitary structure of spatial cognition beyond general intelligence. *Npj Science of Learning, 5*(1), 9. <https://doi.org/10.1038/s41539-020-0067-8>
- Maslennikova, E. P., Feklicheva, I. V., Esipenko, E. A., Sharafieva, K. R., Ismatullina, V. I., Golovin, G. V., Miklashevskiy, A. A., Chipeeva, N. A., & Soldatova, E. L. (2017). Vocabulary size as a verbal intelligence index: Application of the express methods of an estimating vocabulary size. *Bulletin of the South Ural State University Series Psychology, 10*(3), 63–69. <https://doi.org/10.14529/psy170306>
- McGill, R., Tukey, J. W., & Larsen, W. A. (1978). Variations of box plots. *The American Statistician, 32*(1), 12. <https://doi.org/10.2307/2683468>
- McLaren-Gradinaru, M., Burles, F., Dhillon, I., Retsinas, A., Umiltà, A., Hannah, J., Dolhan, K., & Iaria, G. (2020). A novel training program to improve human spatial orientation: Preliminary findings. *Frontiers in Human Neuroscience, 14*, 5. <https://doi.org/10.3389/fnhum.2020.00005>
- McNally, R. J., Robinaugh, D. J., Wu, G. W. Y., Wang, L., Deserno, M. K., & Borsboom, D. (2015). Mental disorders as causal systems: A network approach to posttraumatic stress disorder. *Clinical Psychological Science, 3*(6), 836–849. <https://doi.org/10.1177/2167702614553230>
- Mix, K. S., Levine, S. C., Cheng, Y.-L., Young, C., Hambrick, D. Z., Ping, R., & Konstantopoulos, S. (2016). Separate but correlated: The latent structure of space and mathematics across development. *Journal of Experimental Psychology: General, 145*(9), 1206–1227. <https://doi.org/10.1037/xge0000182>
- Mix, K. S., Levine, S. C., Cheng, Y.-L., Young, C. J., Hambrick, D. Z., & Konstantopoulos, S. (2017). The latent structure of spatial skills and mathematics: A replication of the two-factor model. *Journal of Cognition and Development, 18*(4), 465–492. <https://doi.org/10.1080/15248372.2017.1346658>
- Neubeck, M., Karbach, J., & Könen, T. (2022). Network models of cognitive abilities in younger and older adults. *Intelligence, 90*, 101601. <https://doi.org/10.1016/j.intell.2021.101601>
- Newcombe, N. S., & Shipley, T. F. (2015). Thinking about spatial thinking: New typology, new assessments. In J. S. Gero (Ed.), *Studying visual and spatial reasoning for design creativity* (pp. 179–192). Springer Netherlands. [https://doi.org/10.1007/978-94-017-9297-4\\_10](https://doi.org/10.1007/978-94-017-9297-4_10)
- Papageorgiou, K. A., Likhonov, M., Costantini, G., Tsigeman, E., Zaleshin, M., Budakova, A., & Kovas, Y. (2020). Personality, behavioral strengths and difficulties and performance of adolescents with high achievements in science, literature, art and sports. *Personality and Individual Differences, 160*, 109917. <https://doi.org/10.1016/j.paid.2020.109917>
- Peterson, B. (2020). *PerformanceAnalytics: Econometric tools for performance and risk analysis*. Retrieved from: <https://github.com/brave-rock/PerformanceAnalytics>
- R Core Team. (2017). *R: A language and environment for statistical computing*. R Core Team. Retrieved from: <https://www.R-project.org/>
- Raven, J. C. (1958). *Guide to using the Mill Hill vocabulary scale with the progressive matrices scales* (p. 64). H. K. Lewis & Co.
- Revelle, W. (2013). *Psych: Procedures for Personality and Psychological Research*. R package version 1.3.2. Retrieved from: <http://personality-project.org/r>
- Rimfeld, K., Shakeshaft, N. G., Malanchini, M., Rodic, M., Selzam, S., Schofield, K., Dale, P. S., Kovas, Y., & Plomin, R. (2017). Phenotypic and genetic evidence for a unifactorial structure of spatial abilities. *Proceedings of the National Academy of Sciences, 114*(10), 2777–2782. <https://doi.org/10.1073/pnas.1607883114>
- Robinaugh, D. J., LeBlanc, N. J., Vuletich, H. A., & McNally, R. J. (2014). Network analysis of persistent complex bereavement disorder in conjugally bereaved adults. *Journal of Abnormal Psychology, 123*(3), 510–522. <https://doi.org/10.1037/abn0000002>
- Rodic, M., Tikhomirova, T., Koliienko, T., Malykh, S., Bogdanova, O., Zueva, D. Y., Gynku, E. I., Wan, S., Zhou, X., & Kovas, Y. (2015). Spatial complexity of character-based writing systems and arithmetic in primary school: A longitudinal study. *Frontiers in Psychology, 6*, 333. <https://doi.org/10.3389/fpsyg.2015.00333>
- Rossee, Y. (2012). Lavaan: An R package for structural equation modeling. *Journal of Statistical Software, 48*(2), 1–36.
- Salthouse, T. (2004). Localizing age-related individual differences in a hierarchical structure. *Intelligence, 32*(6), 541–561. <https://doi.org/10.1016/j.intell.2004.07.003>
- Shepard, R. N., & Metzler, J. (1971). Mental rotation of three-dimensional objects. *Science, 171*(3972), 701–703. <https://doi.org/10.1126/science.171.3972.701>
- Silverman, I., Choi, J., Mackewn, A., Fisher, M., Moro, J., & Olshansky, E. (2000). Evolved mechanisms underlying wayfinding. *Evolution and Human Behavior, 21*(3), 201–213. [https://doi.org/10.1016/S1090-5138\(00\)00036-2](https://doi.org/10.1016/S1090-5138(00)00036-2)
- Silverman, I., & Eals, M. (1992). *Sex differences in spatial abilities: Evolutionary theory and data*. In *The adapted mind: Evolutionary psychology and the generation of culture* (pp. 533–549). Oxford University Press.
- Spearman, C. (1904). General intelligence, objectively determined and measured. *The American Journal of Psychology, 15*(2), 201–292. <https://doi.org/10.2307/1412107>
- Spearman, C. (1987). The proof and measurement of association between two things. *The American Journal of Psychology, 100*(3/4), 441. <https://doi.org/10.2307/1422689>
- Stieff, M., Dixon, B. L., Ryu, M., Kumi, B. C., & Hegarty, M. (2014). Strategy training eliminates sex differences in spatial problem solving in a stem domain. *Journal of Educational Psychology, 106*(2), 390–402. <https://doi.org/10.1037/a0034823>
- Stieff, M., & Uttal, D. (2015). How much can spatial training improve STEM achievement? *Educational Psychology Review, 27*(4), 607–615. <https://doi.org/10.1007/s10648-015-9304-8>

- Stoet, G., & Geary, D. C. (2013). Sex differences in mathematics and Reading achievement are inversely related: Within- and across-nation assessment of 10 years of PISA data. *PLoS One*, *8*(3), e57988. <https://doi.org/10.1371/journal.pone.0057988>
- Taube, J. S., Valerio, S., & Yoder, R. M. (2013). Is navigation in virtual reality with fMRI really navigation? *Journal of Cognitive Neuroscience*, *25*(7), 1008–1019. [https://doi.org/10.1162/jocn\\_a\\_00386](https://doi.org/10.1162/jocn_a_00386)
- Toivainen, T., Pannini, G., Papageorgiou, K. A., Malanchini, M., Rimfeld, K., Shakeshaft, N., & Kovas, Y. (2018). Prenatal testosterone does not explain sex differences in spatial ability. *Scientific Reports*, *8*(1), 13653. <https://doi.org/10.1038/s41598-018-31704-y>
- Tosto, M. G., Hanscombe, K. B., Haworth, C. M. A., Davis, O. S. P., Petrill, S. A., Dale, P. S., Malykh, S., Plomin, R., & Kovas, Y. (2014). Why do spatial abilities predict mathematical performance? *Developmental Science*, *17*(3), 462–470. <https://doi.org/10.1111/desc.12138>
- Uttal, D. H., Meadow, N. G., Tipton, E., Hand, L. L., Alden, A. R., Warren, C., & Newcombe, N. S. (2013). The malleability of spatial skills: A meta-analysis of training studies. *Psychological Bulletin*, *139*(2), 352–402. <https://doi.org/10.1037/a0028446>
- Valente, T. W. (2012). Network interventions. *Science*, *337*(6090), 49–53. <https://doi.org/10.1126/science.1217330>
- Van Der Maas, H. L. J., Dolan, C. V., Grasman, R. P. P., Wicherts, J. M., Huizenga, H. M., & Raijmakers, M. E. J. (2006). A dynamical model of general intelligence: The positive manifold of intelligence by mutualism. *Psychological Review*, *113*(4), 842–861. <https://doi.org/10.1037/0033-295X.113.4.842>
- Wai, J., Lubinski, D., & Benbow, C. P. (2009). Spatial ability for STEM domains: Aligning over 50 years of cumulative psychological knowledge solidifies its importance. *Journal of Educational Psychology*, *101*(4), 817–835. <https://doi.org/10.1037/a0016127>
- Zacks, J. M., Mires, J., Tversky, B., & Hazeltine, E. (2000). Mental spatial transformations of objects and perspective. *Spatial Cognition and Computation*, *2*(4), 315–332. <https://doi.org/10.1023/A:1015584100204>
- Zhao, T., Liu, H., & Roeder, K. (2012). The huge package for high-dimensional undirected graph estimation in R. *Journal of Machine Learning Research*, *13*, 1059–1062.

## SUPPORTING INFORMATION

Additional supporting information may be found in the online version of the article at the publisher's website.

**How to cite this article:** Likhanov, M., Maslennikova, E., Costantini, G., Budakova, A., Esipenko, E., Ismatullina, V., & Kovas, Y. (2022). This is the way: Network perspective on targets for spatial ability development programmes. *British Journal of Educational Psychology*, *00*, e12524. <https://doi.org/10.1111/bjep.12524>